

# GENO

# DZ309 DIGITAL TIMER



**Attention**  
Risk of Danger,  
Warning



**High Voltage,**  
Risk of  
Electric Shock



**Double / Reinforced**  
Insulation



**NOT**  
Litter



**CE Mark**

## TECHNICAL SPECIFICATION



- **Dimensions** : 96x96mm
- **Panel Cut-out** : 91x91mm
- **Display** : 2x4 Digits 7 Segment
- **Inputs** : START / RESET / GATE  
3 x 230 VAC (OFF:0..50VAC, ON:150..240VAC)



- **GATE Input** : Inhibits count-down/up when GATE is ON
- **Output** : Out1, Out2; 2 x Relay (NO-O-NC), 250VAC, 2A, Resistive load
- **Time Base** : Selectable; 99:59 hours / 99:59 minutes / 599.9 seconds



- **Resolution** : 1 min. / 1 sec./ 0.1 sec.
- **Accuracy** :  $\pm 0,5 \%$  (Over full scale)
- **Modes** : Selectable 8 different modes
- **Supply Voltage** : 100..240VAC, 50-60Hz



- **Power Consumption** : < 6VA
- **Humidity** : 80% up to 30°C, then linearly decreases to 50% at 50°C (non-condensing)



- **Altitude** : < 2000 m
- **EMC** : EN 61000-6-1, EN 61000-6-3 (Only light industrial environment)
- **Safety** : EN 61010-1; Pollution degree 1, measurement category I, (Only light industrial environment, double/reinforced isolated, non-conductive pollution environment)



- **Protection Class** : IP20; according to EN 60529
- **Storage Temperature** : -10°C .. 60°C (no icing)
- **Operation Temp.** : 0 .. 50 °C
- **Weight** : < 0.5 kg
- **Key** : Micro switch
- **Torque for screwing** : Max. 0.5 N.m

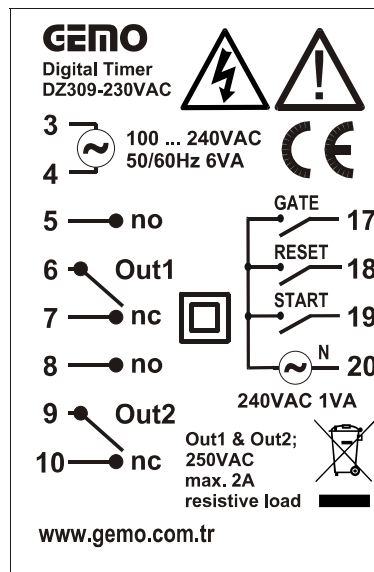







**no:** normally open  
**nc:** normally closed

Gürbüzöğlü Elektronik San. ve Tic. Ltd. Şti.  
Çamlıtepe Cad. No:297 / 3-4 Siteler, Ankara, Türkiye  
Tel: +90-312-3503900, Fax: +90-312-3511117

<http://www.gemo.com.tr>  
e-posta: [info@gemo.com.tr](mailto:info@gemo.com.tr)

## INSTALLATION, USE and WARNINGS

-  ● This device and its packing is NOT litter and may NOT be disposed of with domestic waste. Please return this device and its packing to an appropriate recycling point at the end of its service life.
-  ● Please read this user manual carefully and completely before installation and use. Please take into consideration all warnings mentioned in this manual.
-  ● DZ309 is suitable only for permanent panel type mounting
- Installation and use of this device must be done by qualified, authorized and trained technical personnel only.
- Inspect device carefully before installation. Do not install and use broken and defective devices.
- Do not disassemble device. Do not make any repair on any part of the device. There is no accessible part inside the device. Please contact to manufacturer for broken and defective devices.
- Do not use device in environments subject to flammable, explosive and corrosive gases and/or substances.
- This device is designed for applications only in light industrial environments. This device is not suitable for medical and residential use. This device is not suitable for use related with human health and safety. This device is not suitable for automotive, military and marine use.
- Do not allow children and unauthorized people to use this device.
- Before installation and any technical work, disconnect the power supply and mains connections.
- Check the power supply voltage level before power on, and make sure voltage level is in specified limits. Check quality of neutral line. Improper neutral line may give permanent damage to the device.
-  ● Connect an external power switch and an external fuse (1A, 250VAC) to the power supply line that are easily accessible for rapid intervention. Connect an external fuse (2A, 250VAC) for each relay output separately.
- Use appropriate cables for power supply and mains connections. Apply safety regulations during installation.
- Install the device in a well ventilated place. Install the device permanently into a proper panel cut-out. Fix the device with two fasteners supplied with the device. Only front panel must be accessible after installation is completed.
- Do not operate the device other then the environmental conditions given in Technical Specification.
- Do not operate the device in environments that may cause conductive pollution.
-  ● Take precautions against negative environmental conditions like humidity, vibration, pollution and high/low temperature during installation.
- Keep device, signal cables and communication cables away from circuit breakers, power cables and devices/cables emitting electrical noise. Use shielded and twisted signal and communication cables and connect shield to earth ground on device side. Keep length of signal and communication cables less than 3m.
- In your applications, always use separate and independent mechanical and/or electromechanical devices/apparatus to support DZ309 to handle emergency cases..
-  ● Use insulated cable end-sleeves at the end of cables screwed to the device connector terminals.
- Maximum torque for screwing; 0.5 N.m.
- Please check [www.gemo.com.tr](http://www.gemo.com.tr) for latest device and documentation updates regularly. All updates and all information are subject to change without notice.

## GENERAL SPECIFICATION

- This device is designed for basic timer applications only in light industrial environments.
- $\mu$ P based Digital Timer with START/RESET/GATE input
- 2x4 7 Segment LED display
- Selectable 8 different modes
- Counts hour / minute / second
- Loads Timer value & OUT status at the latest power failure after the first power on
- Displays SET or remaining time
- EEPROM memory to store settings
- 96x96mm
- Easy connection with plug-in connectors

**FRONT PANEL RESET**

**PROGRAMMING TIMER SET VALUE**

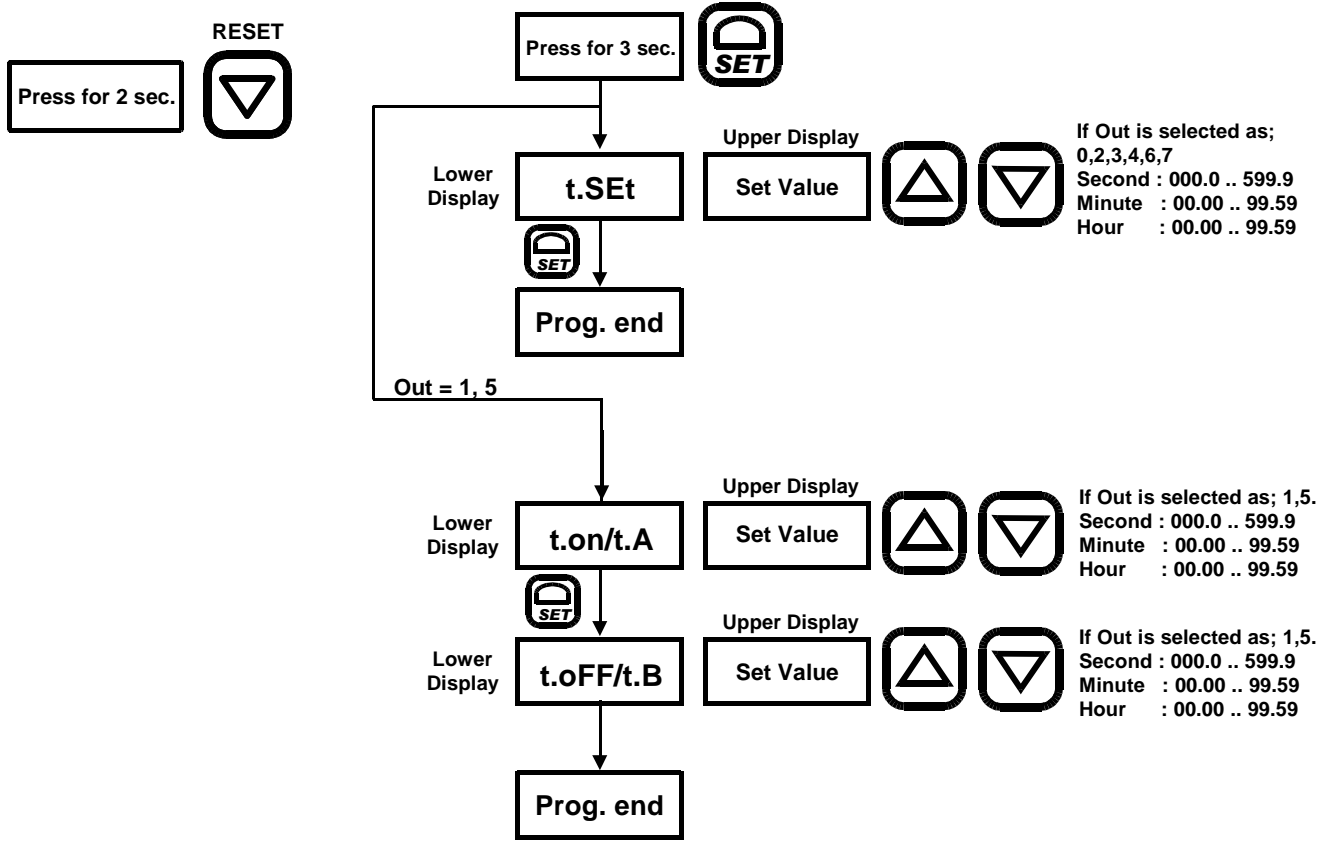

**SELECTING TIME BASE & MODES**

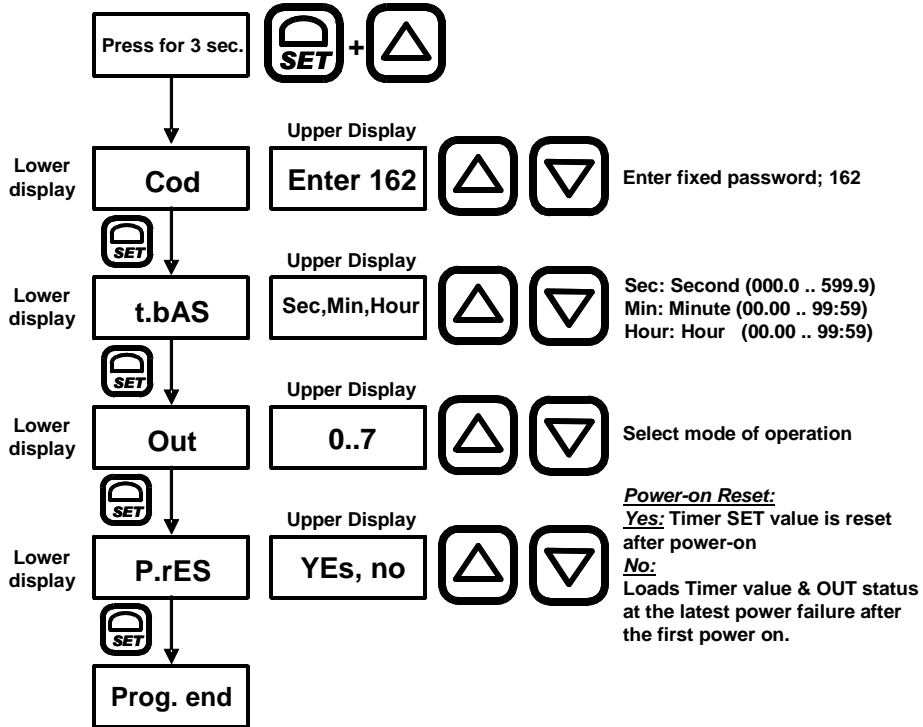

## MODES OF OPERATION

### Mode : 0; Pulsed Delay, OFF with RESET

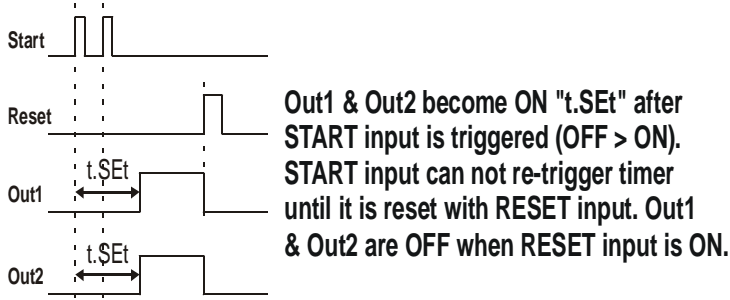

### Mode : 1; Flashing with START/RESET

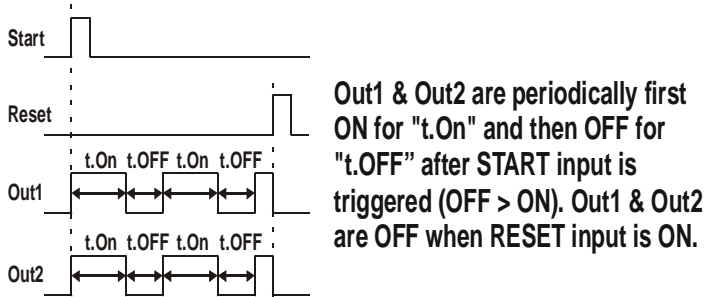

### Mode : 2; One Shot after ON and OFF

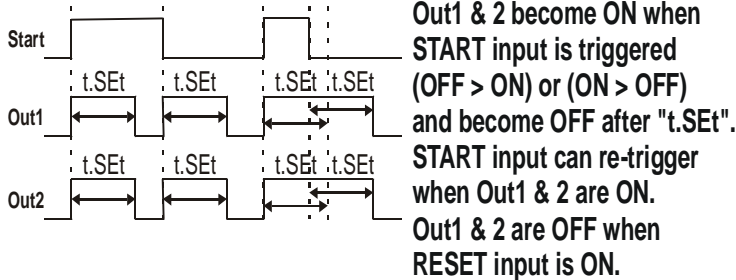

### Mode : 3; OFF Delay

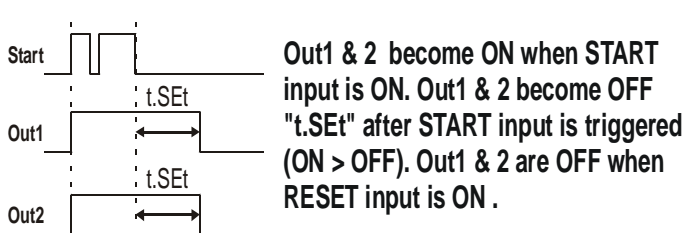

### Mode : 4; Follow & ON Delay

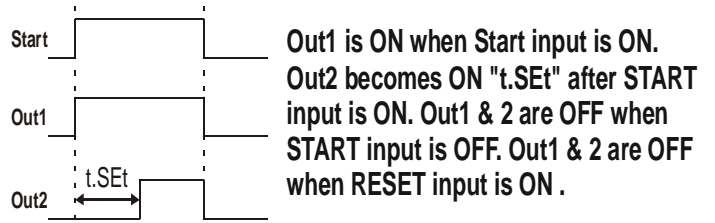

### Mode : 5; Delayed One Shot after OFF

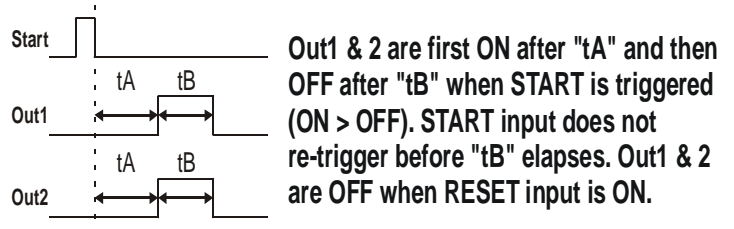

### Mode : 6; Chronometer - Count with START

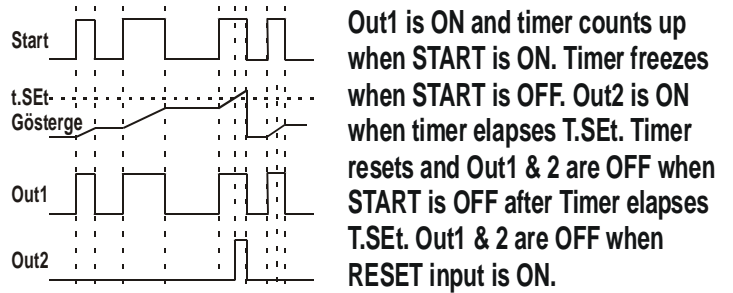

### Mode : 7; Chronometer-Count with START, Reset with RESET

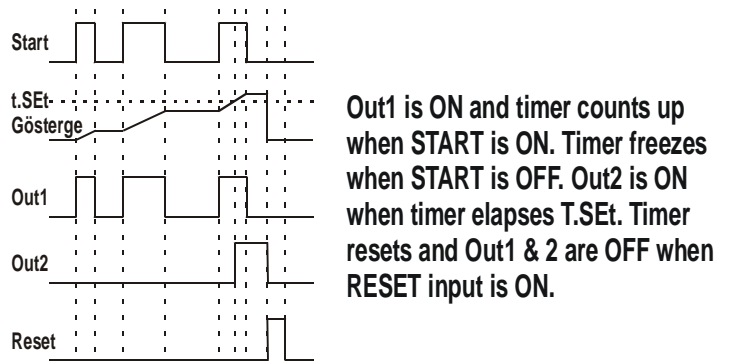

### Notes:

1. For Mode1; t.On and t.OFF are accepted as min. 000.1 sec, 00.01 min. and 00.01 hr.
2. Timer counts up for Mode 6 & 7, and down for other modes.
3. For all modes; counting is inhibited (freeze) when GATE is ON.

## CLAENING

Do not use any solvents (alcohol, thinners, benzine, acid, etc.) or corrosive substances to clean the device. Use only a dry and clean non-abrasive cloth. Before cleaning, disconnect the power supply and mains connections.

